



INSTRUCTION MANUAL

Model GLD-RDO



Light Commercial Roller Door Operator

- THIS OPERATOR IS TO BE INSTALLED AND SERVICED BY A TRAINED TECHNICIAN ONLY
- Compatible with Security+ 2.0® accessories
- Compatible with Grifco Battery Backup and MyQ Internet Gateway

Chamberlain Australia Pty Ltd
Unit 1, 75 Epping Rd North Ryde NSW 2113
Ph: 1800 GRIFCO
www.grifco.com.au

Ref: 114A5187C

GRIFCO®

SAFETY SYMBOL AND SIGNAL WORD REVIEW

This commercial roller door operator has been designed and tested to offer safe service provided it is installed, operated, maintained and tested in strict accordance with the instructions and warnings contained in this manual.

 **WARNING**
Mechanical























 **WARNING**
Electrical

When you see these Safety Symbols and Signal Words on the following pages, they will alert you to the possibility of serious injury or death if you do not comply with the warnings that accompany them. The hazard may come from something mechanical or from electric shock.

CAUTION

When you see this Signal Word on the following pages, it will alert you to the possibility of damage to your commercial door and/or the commercial door operator if you do not comply with the cautionary statements that accompany it.

THESE ARE IMPORTANT SAFETY INSTRUCTIONS. FOLLOW ALL INSTRUCTIONS AS INCORRECT INSTALLATION CAN LEAD TO SEVERE INJURY OR DEATH

- | | | | |
|--|---|---|---|
|  | Keep commercial door balanced. Sticking or binding doors must be repaired. Commercial doors, door springs, pulleys, brackets and their hardware are under extreme tension and can cause serious personal injury. Do not attempt to loosen, move or adjust them. Call for commercial door service. |  | Permanently fasten all supplied labels adjacent to the wall control as a convenient reference and reminder of safe operating procedures. |
|  | Do not wear rings, watches or loose clothing while installing or servicing a commercial door operator. |  | Disengage all existing commercial door locks to avoid damage to commercial door. Install the wall control (or any additional push buttons) in a location where the commercial door is visible during operation . Do not allow children to operate push button(s) or remote transmitter(s). Serious personal injury from a closing commercial door may result from misuse of the operator. |
|  | To avoid serious personal injury from entanglement, remove all ropes connected to the commercial door before installing the door operator. |  | Activate operator only when the door is in full view, free of obstructions and operator is properly adjusted. No one should enter or leave the building while the door is in motion. |
|  | Installation and wiring must be in compliance with your local building and electrical codes. Connect the power supply cord only to properly earthed mains. |  | An electrician must disconnect electric power to the commercial door operator before making repairs or removing covers. |
|  | Moisture and water can destroy the electronic components. Make sure under all circumstances that water moisture or storage moisture cannot penetrate the electronics. The same applies for openings and cable entries. |  | The actuating member of a biased-off switch is to be located within direct sight of the door but away from moving parts. Unless it is key operated, it is to be installed at a minimum height of 1500mm and not accessible to the public. |
|  | After the installation a final test of the full function of the system and the full function of the safety devices must be done. |  | Make sure that people who install, maintain or operate the door follow these instructions. Keep these instructions in a safe place so that you can refer to them quickly when you need to. |
|  | When operating a biased-off switch, make sure that other persons are kept away. |  | This appliance is not intended for use by persons (including children) with reduced physical, sensory or mental capabilities, or lack of experience and knowledge, unless they have been given supervision or instruction concerning use of the appliance by a person responsible for their safety. Children should be supervised to ensure that they do not play with the appliance. |
|  | The operator cannot be used with a driven part incorporating a wicket door (unless the operator cannot be operated with the wicket door open). |  | Use the commercial rolling door operator for its intended purpose. The GLD-RDO operator is designed lifting spring-balanced roller doors. |
|  | Operator may become hot during operation. Appropriate clearance and/or shielding should be supplied by the installer to ensure any cabling, wiring and/or other items cannot come in contact with the operator. If temperature rise exceeds 50°C all fixed wiring insulation must be protected, for example, by insulating sleeving having an appropriate temperature rating. |  | Automatic Drive - Keep away from the area of the door as it may operate unexpectedly. |
|  | If the supply cord is damaged, it must be replaced by the manufacturer, its service agent or similarly qualified persons in order to avoid a hazard. |  | WARNING! Product includes wireless transmitters and wall controls that contain coin/button cell batteries. Keep wireless devices and batteries away from children. Battery can cause severe or fatal injuries in 2 hours or less if swallowed or placed inside any part of the body. Seek immediate medical attention if it is suspected that a coin/button cell battery has been swallowed or placed inside any part of the body. |
|  | Do not allow children to play with operator wall controls or remote controls. Keep remote controls away from children. |  | |



WARNING: Important safety instructions
It is important for the safety of persons to follow all instructions. **SAVE** these instructions

IMPORTANT



REMOVE CHAIN REDUCTION ASSEMBLIES that may interfere with the safe and proper operation of the LR-Drive (GLD-RDO).

REMOVE HAND CHAINS prior to fitting the LR-Drive (GLD-RDO).

DO NOT USE Extension Poles with the LR-Drive (GLD-RDO).

USE WITH WINDLOCKED DOORS:

- Door is professionally installed, correctly sprung and maintained in accordance with manufacturer's instruction
- Door size up to 22m²
- Product is only operated in normal conditions, not during adverse wind conditions

CONTENTS

SAFETY SYMBOL AND SIGNAL WORD REVIEW	2
INTRODUCTION	3
OPERATOR SPECIFICATIONS	4
DOOR REQUIREMENTS.....	4
CONTROL PANEL OVERVIEW	5
CARTON INVENTORY	6
TOOLS REQUIRED.....	6
HARDWARE PROVIDED.....	6
INSTALLATION.....	7
TESTING THE DOOR.....	7
INSTALLING THE STOP COLLAR.....	7
PINING THE DOOR	7
THE RELEASE HANDLE & CORD	8
OPERATING THE RELEASE HANDLE	8
LEFT HAND / RIGHT HAND INSTALLATION	8
INSTALLATION PROCEDURE	9
ATTACHING BATTERY BACKUP UNIT (BBU).....	10-11
COMMISSIONING.....	12
PROGRAMMING TRAVEL LIMITS AND FORCE SETTINGS	12
TESTING THE SAFETY REVERSE SYSTEM.....	13
FIXING THE WARNING LABELS	13
INSTALLING THE E138G WIRELESS WALL BUTTON	14
SETTING TIMER-TO-CLOSE (TTC).....	14
AUDIBLE BEEP	15
PROGRAM THE TRAVEL SPEED.....	15
VENTILATION MODE - PARTIALLY OPEN FEATURE.....	15
COMMISSIONING REMOTE TRANSMITTERS	16
COMMISSIONING KEYSWITCH	17
COMMISSIONING MYQ	17
COMMISSIONING FIRE OPEN INPUT.....	17
TYPES OF SECURITY +2.0 TRANSMITTERS.....	18
MAINTENANCE AND CARE	19
USING YOUR OPERATOR	19
REPLACING BATTERIES	20
TROUBLESHOOTING	21
DIAGNOSTICS	22
SERVICE AND REPAIR PARTS	23
CHAMBERLAIN LIMITED WARRANTY	24

INTRODUCTION

OPERATOR SPECIFICATIONS

Power Specifications	
Main AC Power Supply	230-240 Vac 50Hz
Max. Pull Force	1,300N
Power	150W
Operating Temperature	+5°C to +60°C
Door Specifications	
Max Door Height	5.5m
Max Door Weight	270kg
Max Lift under Spring Tension	20kg
Normal Torque	45Nm
Maximum Door Area	Commercial Steel Spring-Balanced Roller Doors up to 28m ²
Max. Door Cycles	50 cycles / day
Dimensions	
Operator Height	470mm
Operator Width	280mm
Operator Depth	95mm, 150mm with BBU (Door Curtain to Wall)
Compliance	
	AS/NZS 60335-1 AS/NZS 60335-2-103
Transmitter Specifications	
Hand Transmitters	64 devices
Keypad Transmitters	2 devices
Operator Frequency	433.30 / 433.92 / 434.54 MHz
Transmitter Management	Compatible with STAR1000EVO (accessory sold separately)
Usage	
	Indoor Use Only

DOOR REQUIREMENTS

The maximum allowable height is 5.5m (light commercial door) with a maximum curtain area of 28m² (door height in metres multiplied by the width in metres). The door must be of corrugated sheet construction, spring balanced & of a mass not exceeding 270 kg. Door axle diameter must not exceed 35 mm.

Ensure that there is at least 45 mm from the edge of the curtain to the edge of the bracket. If the roller door drum is on the edge of the curtain or is a smaller diameter, additional clearance may be required. (Ensure there is a power point near the operator.)

NOTE: The installer is required to check that the temperature range marked on the drive is suitable for the location.

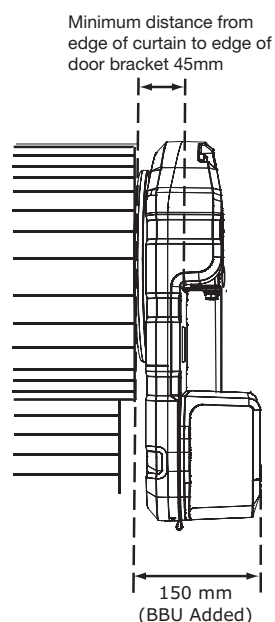

WARNING

A 240V General Purpose Outlet (GPO) ie. Power Point must be available in close proximity to the operator. This fitting is not part of the operator hardware and must be supplied by the consumer.

INTRODUCTION

CONTROL PANEL OVERVIEW

Control Panel is accessible under the front cover at the bottom of the operator.

1.	Down Button	Used for initial programming, driving the door down and for displaying diagnostic codes - Digit 1
2.	Up Button	Used for initial programming, to drive the door up and for displaying diagnostic codes - Digit 2
3.	Prog Button	Used to program door limits and other features
4.	"S" Button	Used for programming remote access devices, MyQ and manual learning of forces
5.	Indicator LED	Used to indicate various programming modes
6.	External Accessory Power	30 Vdc 50mA available. Constant supply (no low standby) unregulated.
7.	Terminal Blocks	Used to configure external accessories. See chart below for the function of each terminal block.

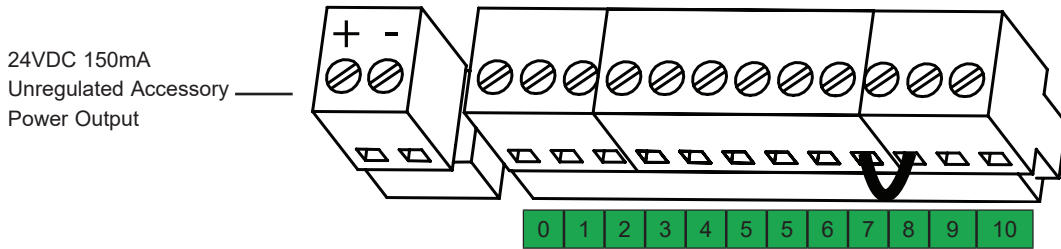
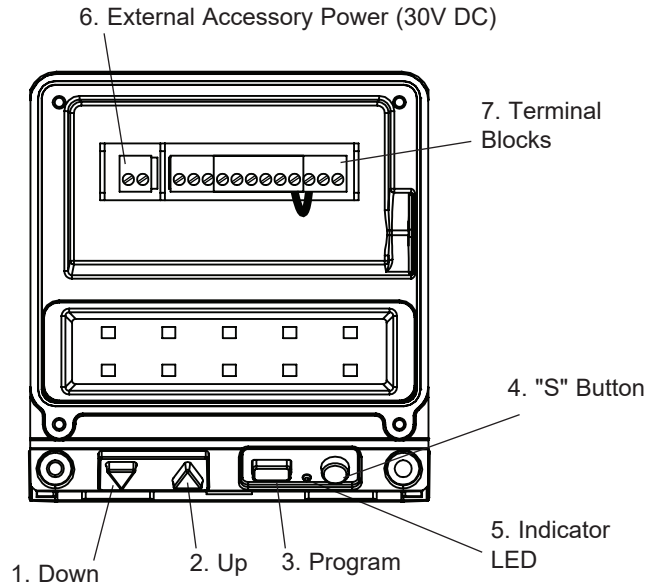

Terminal Block Functions

No.	Function	Polarity	Comment
0	E-Serial port	+ve	Serial Communication Input
1	Door	+ve	N/O Dry Contact input for Open/Stop/Close wall control
2	Open/only	+ve	OPEN control input
3	Close/only	+ve	CLOSE control input
4	Hold to close	+ve	N/O Dry contact for HOLD to CLOSE input. Will not override Entrapment Protection System
5	GND	-ve	Common for all wired access control devices
5	GND	-ve	Common for IR Beam (Entrapment Protection System)
6	IR Beam +	+ve	IR Beam (Entrapment Protection System) input (pulsing type only)
7	E Stop +	+ve	E stop + control (7 & 8 are normally linked)
8	E Stop -	-ve	E stop - control (7 & 8 are normally linked)
9	Accessory Power +	+ve	Regulated power supply +24VDC 150 ma while door in motion
10	Accessory Power -	-ve	Regulated power supply negative terminal

INTRODUCTION

CARTON INVENTORY

GLD-RDO contains the operator, battery backup, mounting hardware and accessories.

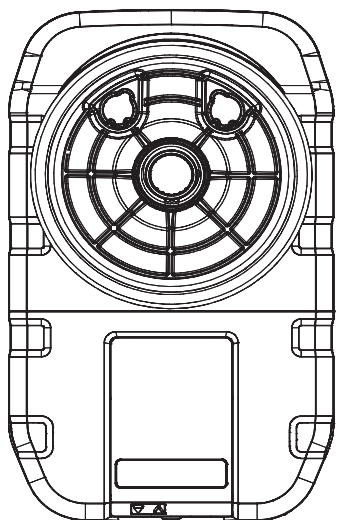

GLD-RDO

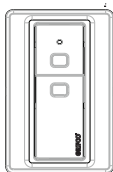

1 x Grifco
2-Channel Wireless
Wall Control

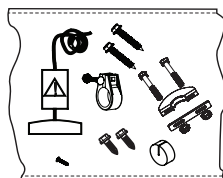

Hardware Bag



Warning Label

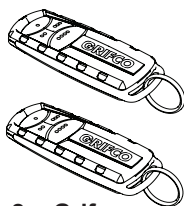

2 x Grifco
4-Channel Transmitters

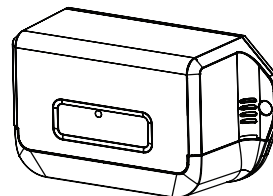

GLD-BBU24V

TOOLS REQUIRED

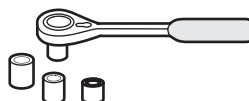
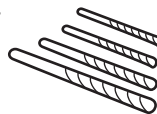
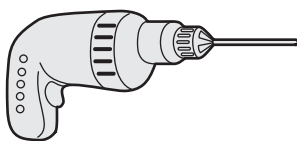
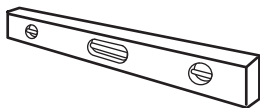
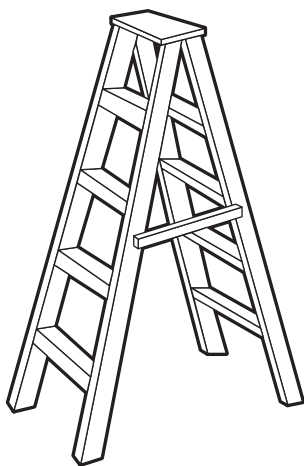

HARDWARE PROVIDED

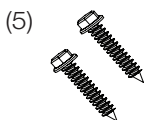
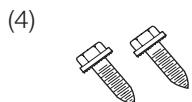
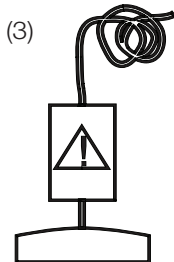
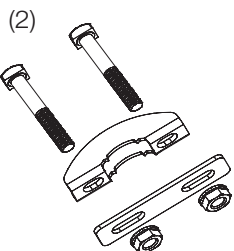
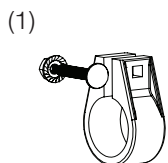

- (1) Stop Collar Assembly
- (2) Clamp Assembly
- (3) Release cord
- (4) Self tapping door pinning screws x 2
- (5) BBU wall or ceiling screws x 2
- (6) BBU screw x 1
- (7) Rubber grommet

INSTALLATION



WARNING

Before beginning installation of the operator check the door is in good mechanical condition, opens and closes properly and correctly balanced

STEP 1

TESTING THE DOOR

Complete the following test to ensure your door is well balanced, and not sticking or binding:

- Disable all locks and remove any ropes connected to the door.
- Lift the door to about halfway and then release it. The door should remain spring balanced.
- Raise and lower the door to determine if there are any sticking or binding points (20 kg of force is the absolute maximum allowable to raise or lower the door in any position).
- If your door does not hold in place or the door binds, sticks or requires excessive force to move, call a qualified door technician before installing the operator.

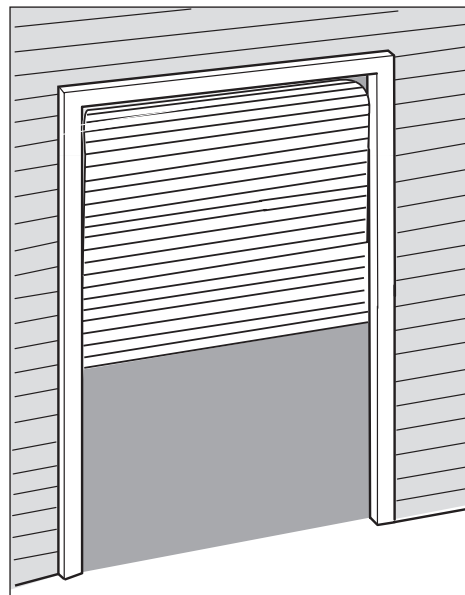

STEP 2

INSTALLING THE STOP COLLAR

- Install the stop collar on the opposite end to where the operator is to be installed.
- Fit the stop collar hard against the boss of the door drum. Ensure the U-bolt holding the door shaft to the door bracket is tightly secured.

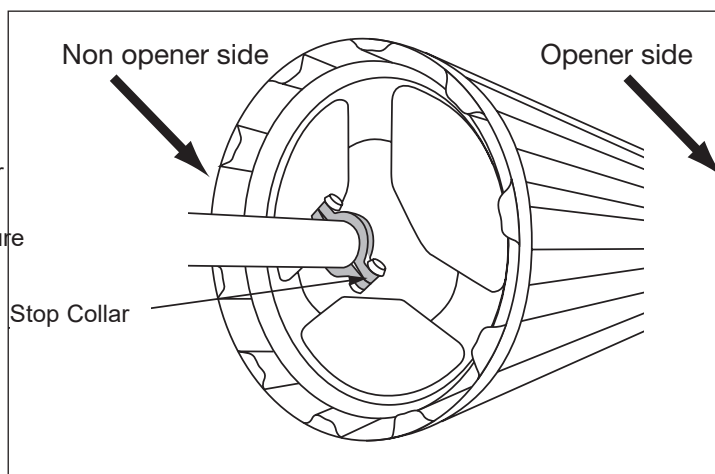

STEP 3

PINNING THE DOOR

Note: A ballooning door may delay the safety reversal response and can compromise door security.

- To remedy any ballooning place self tapping metal screws or rivets where the curtain leaves the roll. Secure these through the curtain into the drum wheel at each end of the roll.
- After determining the correct fastener location as shown, lift the door approximately half a turn from the closed position to allow access for drilling.

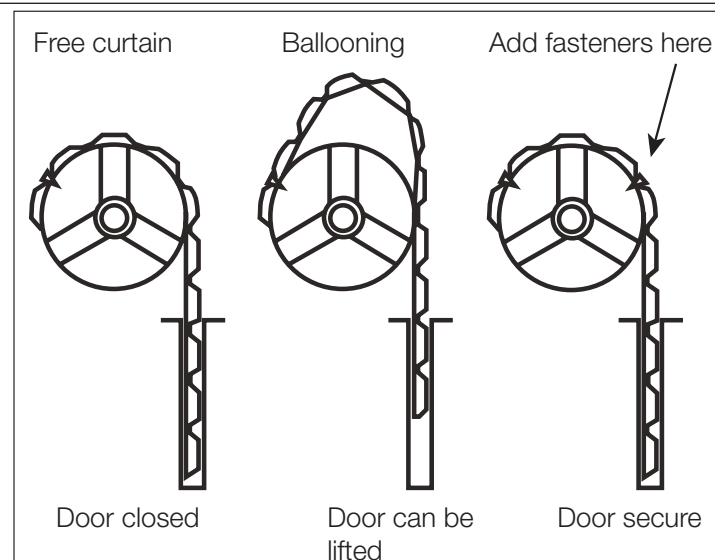

INSTALLATION

STEP 4

THE RELEASE HANDLE & CORD

- Thread one end of the rope through the hole in the top of the red release handle so that "NOTICE" reads right side up as shown.
- Secure with an overhand knot at least 25mm from the end of the rope to prevent slipping.
- Thread the other end of the rope through the loop of the manual release cable.
- Adjust rope length so the handle (when installed) will be no higher than 1.8 m above the floor. Secure with an overhand knot.

NOTE: Final adjustment of handle height should be completed after the operator is installed. If it is necessary to cut the rope, heat seal the cut end to prevent unravelling.

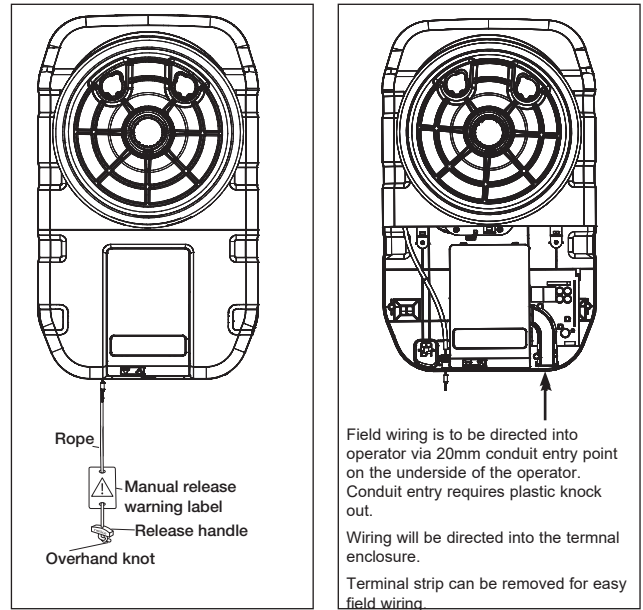

STEP 5

OPERATING THE MANUAL RELEASE

To disengage the opener

Pull the release cord down firmly,
(opener will make a clicking noise).

To re-engage the opener

Pull the release cord down firmly,
(opener will make a clicking noise).

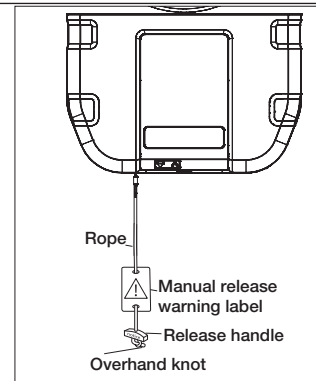

Disable all locks and remove any ropes connected to the door.

Take care when operating the manual release as an open door may fall rapidly due to weak or broken springs, or being out of balance.

STEP 6

IDENTIFY LEFT OR RIGHT HAND INSTALLATION

Refer to Step 8 for instructions on changing left and right hand operator installation.

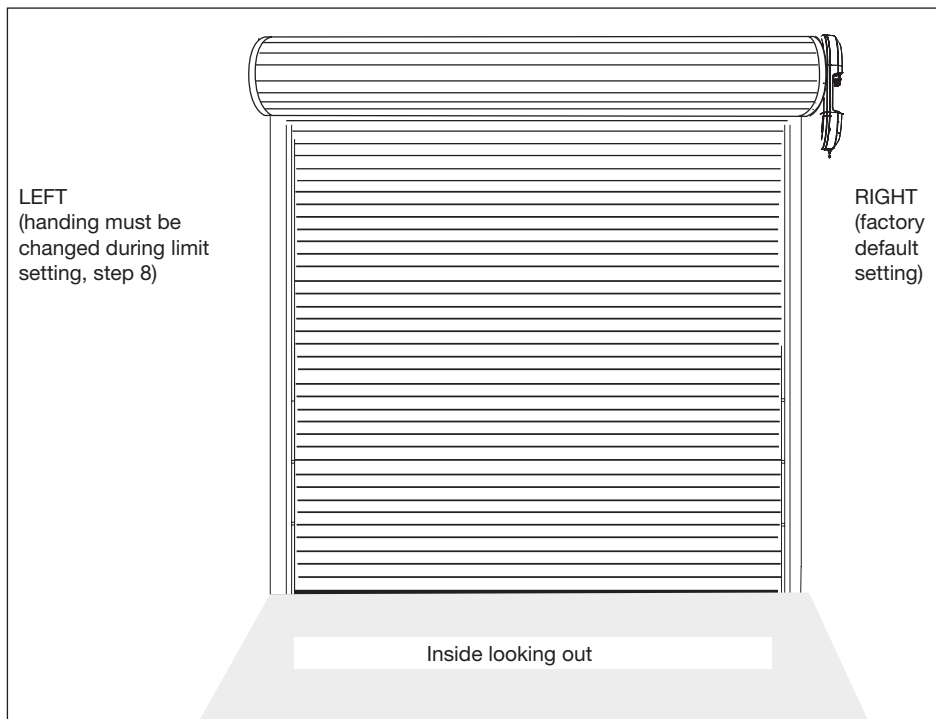

INSTALLATION

STEP 7

INSTALLATION PROCEDURE

 Do not allow people to walk under or around the door during the installation process as serious injury can occur.

NOTE: The operator can be installed on either side of the door. The following instructions are for **RIGHT HAND INSTALLATIONS** (as illustrated i.e. inside the garage looking out). For left hand installations, reverse the instruction terminology (eg **LEFT** for **RIGHT** etc).

Preparation:

- Place the operator in manual release mode (refer section 5).
- Open the roller door fully. For safety, tie a rope around the door.
- Ensure the door axle U-BOLT and door mounting bracket on the left hand side (non operator side) are securely fastened.
- Support the door with a door stand or similar device to safely support the door.
- Mark the position of the door shaft on the right hand door bracket (for reassembly purposes).
- While the door is supported, remove the right hand axle U-Bolt and door mounting bracket from the wall.

Install the operator:

- Slide the operator over the door axle and engage the drive legs into the door drum wheel, either side of a spoke.
- Refit the door mounting bracket to the wall. If the door bracket needs to be relocated due to operator width.
- Clamp the operator on the door axle and door bracket in the marked position using the clamp assembly supplied (tighten to 25 – 28 Nm).
- If side room exceeds 95mm clamp independently to the door axle as illustrated
- Remove all ropes and the support stand.
- Check the operation of the door in manual mode by raising and lowering by hand. It should operate smoothly without sticking or binding. The disengage handle should already be attached less than 1.8 m above the floor.

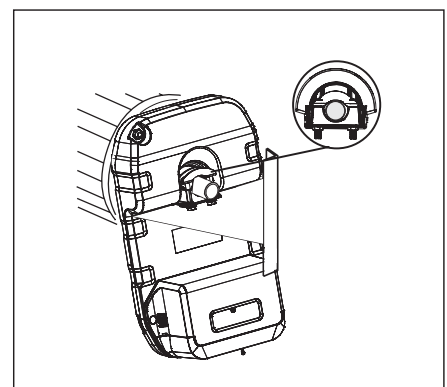
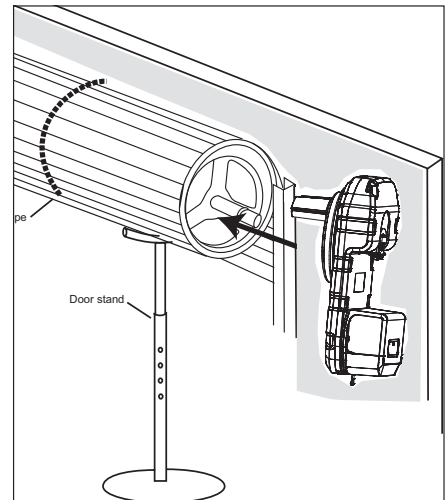
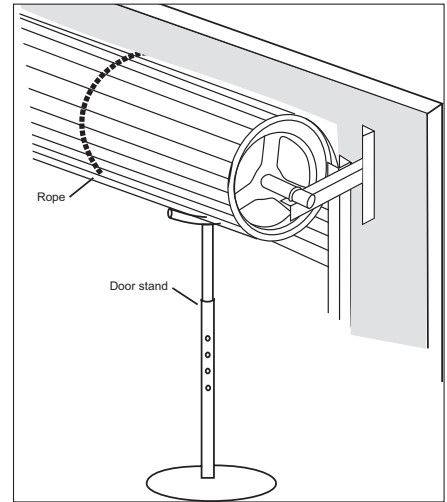

WARNING

Connect Electric Power

TO AVOID INSTALLATION DIFFICULTIES, DO NOT RUN THE DOOR OPERATOR UNTIL INSTRUCTED TO DO SO

Connect to properly fused and earthed power outlet.

- Position the power cable away from the door curtain and any moving parts
- Ensure all ropes and installation tools have been removed from the door
- When the operator is switched ON, the operator light flashes and then remains ON.

STEP 8

ATTACHING THE BATTERY BACKUP

Mounting the BBU to the LR-Drive - Figure 1 (Common) - Install the BBU after the operator has been installed.

Attach the BBU to the LR-Drive on the clips provided:

- Disconnect the mains power from the Operator.
Remove the plastic cover from the BBU housing and expose the looped cable assembly.
- Install the BBU onto the rear cover of the operator assembly, ensure you engage the plastic lugs on the lower half of the housing.
- Tighten the retaining screw provided into the centre housing to secure the BBU.
- Connect the BBU cable into the terminal assembly on the Operator.
- Replace the plastic BBU cover.
- Plug the LR-Drive into AC power and turn the AC power on for the BBU to be activated.
- Check the BBU LEDs activate for 3 seconds, and then the green LED commences flashing, indicating the BBU is charging.

Mounting the BBU to the wall or ceiling - Figure 2 (Optional) Install the BBU after the operator unit has been installed.

- Disconnect mains power from the Operator unit.
- Remove the plastic cover from the BBU housing and expose the looped cable assembly.
- Remove the two plastic plugs from the mounting position on each side of the BBU. (ready to install the mounting screws provided)
- Mount the BBU to the wall or ceiling using the 2 screws provided on a support beam within cable distance. (around 80cm).
- Install the BBU securely onto the support beam and connect the cable to the operator unit.
- Replace the plastic BBU cover, ensure to cable is positioned in the cut-out provided.
- Plug the LR-Drive into AC power and turn the AC power on for the BBU to be activated.
- Check the BBU LEDs activate for 3 seconds, and then the green LED commences flashing, indicating the BBU is charging.

NOTE: The AC power needs to be turned on with the BBU connected for the BBU to be activated.

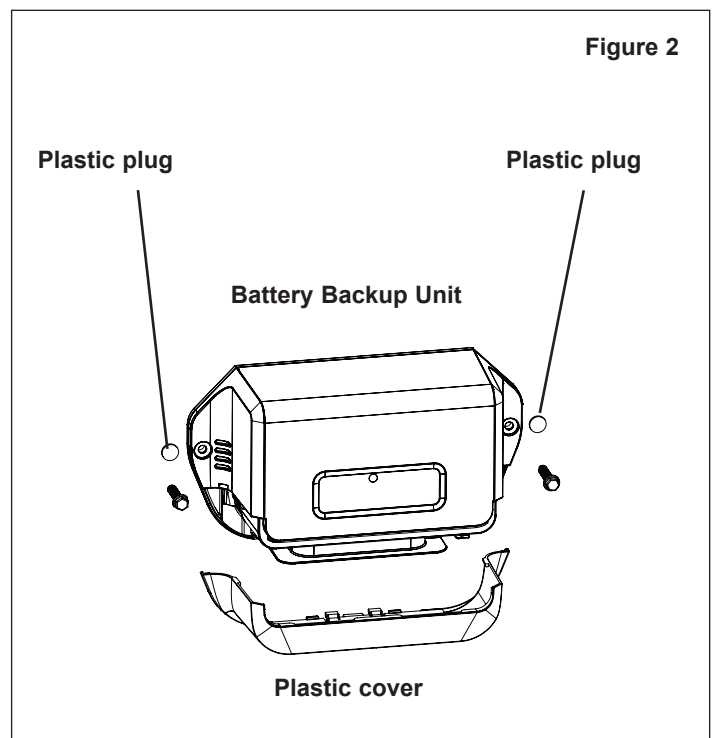
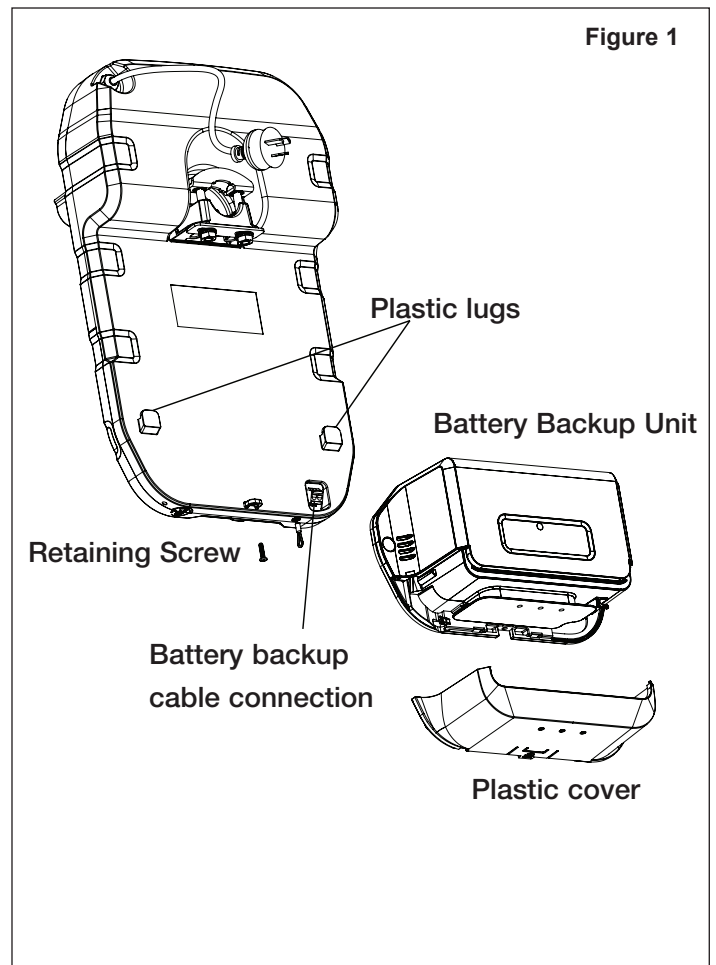

BATTERY BACKUP (BBU) OPERATING INSTRUCTIONS

1. Test the installed BBU with the operator unit.

To test the BBU, disconnect the operator unit power cord from the electrical outlet.

- A solid yellow LED indicates the BBU is operating on battery power.
- A flashing yellow LED with beep indicates the BBU is operating on battery power and that the battery charge is low.
- To test the BBU is functioning properly, open and close the garage door.
- Re-connect the operator unit power cord back into the electrical outlet.
- Verify that the green LED is flashing on the BBU (indicates that the BBU is now charging).
- Test completed

2. Charge the battery.

- Allow the batteries 24 to 48 hours to fully charge before using the BBU system.

A fully charged BBU supplies 24V DC to the operator unit for one to two days of normal operation during an electrical power outage. If the battery voltage drops too low, the batteries will disconnect and the operator unit will no longer operate under battery power.

After the electrical power has been restored, the batteries will recharge within 48 hours. Under normal usage batteries will last 3 to 5 years.

To obtain maximum battery life and prevent damage, also disconnect the battery backup if you unplug the operator unit while on vacation or any other extended period of time.

NOTE: Door operation may be limited until batteries are fully charged. The operator unit's lights will not turn on during BBU mode.

BATTERY BACKUP (BBU) DIAGNOSTICS

Battery Backup Unit (BBU) Diagnostics

GREEN LED:

All systems are normal.

- A solid LED light indicates the batteries are fully charged.
- A flashing LED indicates the batteries are being charged.

NOTE: Batteries do not have to be fully charged to operate the operator unit.

YELLOW LED:

The operator unit has lost power and is operating off of the BBU.

- A solid LED with beep, sounding approximately every 2 seconds, indicates the operator unit is activating the door and is operating off of the BBU.
- A flashing LED with beep, sounding every 30 seconds, indicates batteries are low.
- Once the power is restored the BBU will recharge. This is indicated by a flashing green LED.

RED LED:

An error has been detected and the BBU will automatically shut off. The BBU will attempt to restart by reconnecting to the batteries. If the error is still present it will shut itself off again. This process will repeat every 5 minutes or until the error has been resolved. This is used to prevent further draining of the batteries.

- If a red LED remains on when the power is restored, and is accompanied by a beep sounding every 30 seconds, please call for service.

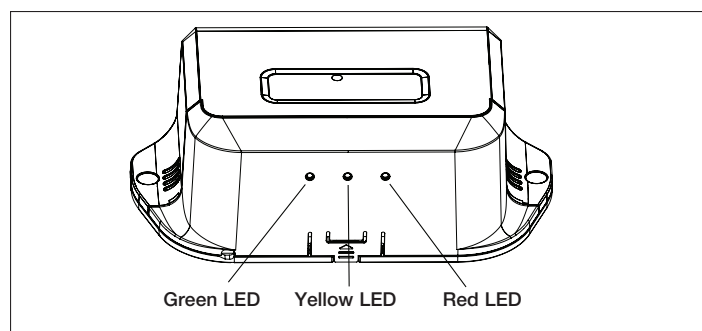

STEP 9

PROGRAM THE TRAVEL LIMITS AND FORCE SETTINGS

Travel limits set how far your door goes up and down. Your operator must also be configured for right or left hand installation. If not the door will rotate in the reverse direction.

Program Buttons: The Control Panel diagram on page 6 identifies the Control Buttons and LED layout. Remove the cover.

Audible Beep: An audible “BEEP” also occurs with each button press. This feature can be turned OFF

Courtesy light: During the programming sequence, the courtesy light will be at half strength

NOTE: The LR-Drive (GLD-RDO) operator is factory configured for right hand installation.

 **The operator will operate during this procedure. Make sure the door is clear of obstruction. Ensure your hands are away from any moving parts before activating the door.**

Setting the Right or Left Hand Operation:

Refer to the diagrams on the right for guidance.

Ensure the door is positioned halfway and the operator is engaged (out of manual mode).

Turn the operator Power ON, the courtesy light will turn ON.

1. Press the “P” button for 5 seconds until the indicator LED will flash, as well as the UP or DOWN arrow. For Right Hand setting, UP will flash, and for Left Hand setting, DOWN will flash.
2. To change to the opposite setting, simply press the “S” button, and the opposite LED will flash.
3. When the correct hand setting is selected, Press and Release the “P” program button to accept this setting. (continue)

Setting the Door Limits:

4. Press and hold the UP button until the door reaches the desired OPEN position (You can toggle between the UP and DOWN buttons to move the door to the correct position. Make sure there is enough room for your vehicle to pass under)
5. Press and release the “P” program button to accept this setting.
6. Press and hold the DOWN button until the door reaches the desired CLOSED position (You can toggle between the UP and DOWN buttons to move the door to the correct position.)
7. Press and release the “P” program button to accept this setting. (UP should flash to indicate you are now in Force Learn mode) (continue)Setting the Force Automatically:
8. Press and release the UP button. The door will travel to the OPEN position with UP flashing.
9. Press and release the DOWN button. The door will travel to the CLOSED position with DOWN flashing. When fully closed, DOWN will stop flashing and the courtesy light will change to full power.

(This process is now complete)

Setting the Force manually: (Only perform if Limits are already set)

- Start with the door fully CLOSED.
- Press the “S” button twice to enter into force learn mode. The Courtesy light will go to half strength, and UP will flash quickly.
- Press and release the UP button. The door will travel to the OPEN position, then DOWN will flash quickly.
- Press and release the DOWN button. The door will travel to the CLOSED position, then DOWN will stop and the courtesy light will change to full power.

(This process is now complete.)

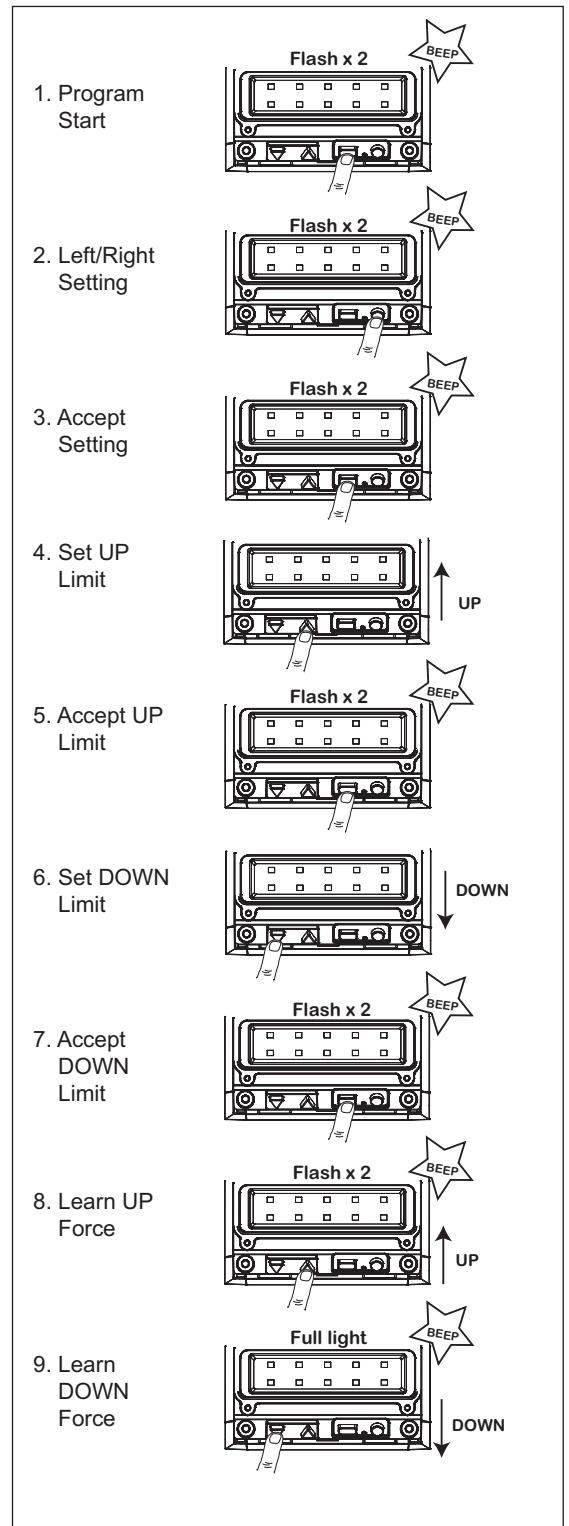

STEP 10

TESTING THE SAFETY REVERSE SYSTEM

WARNING

The safety reverse system test is important.

The door must reverse on contact with a 40 mm obstacle laid flat on the floor. Failure to properly adjust the operator may result in serious personal injury from a closing door.

Operate the door in the down direction. The door must reverse upon contact with the obstacle. If the door stops on the obstacle, remove obstacle and repeat limit and force setting (refer Step 8). **Repeat test of the safety reverse system.**

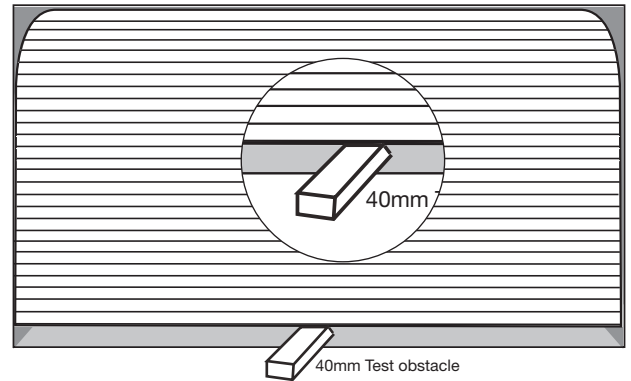

STEP 11

FIXING WARNING LABELS

Once you have completed your installation and successfully carried out the safety reverse system test (outlined above), install the warning labels provided with your operator as shown.

The **risk of entrapment WARNING label** MUST be installed adjacent to the release handle at a height of less than 1.8 m from the floor in a prominent place.

If required, use an eye bolt or hook (not included) to guide the release handle rope.

Any fixed wall control or wireless door control must be mounted at a height of no less than 1.5 m **out of the reach of children**.

Ensure the manual release instruction card is attached to the rope as detailed in step 4.

Read the safety instructions (page 1) for further details concerning safety.

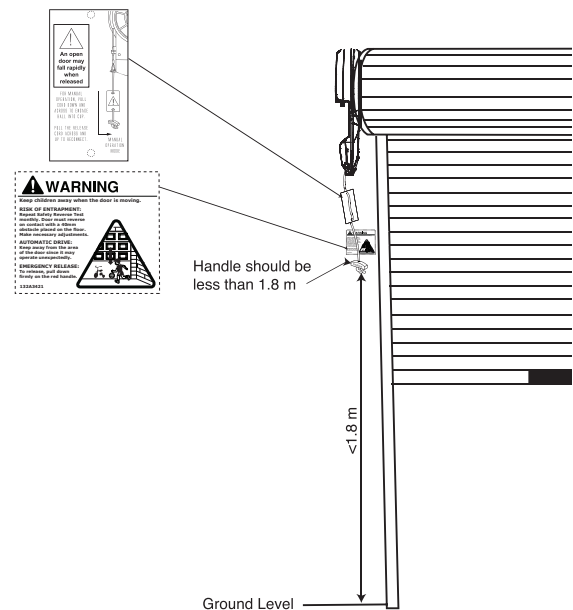

STEP 12

INSTALLING THE E138G WIRELESS WALL BUTTON

To install:

- Carefully pry open the E138G and locate the two screws for mounting.
- Attach to the wall using the two screws and wall anchors provided if mounting to a plaster wall. If using a recessed wall box do not use anchors.

NOTE: Do not overtighten screws.

NOTE: The wall control supplied with your operator should be pre-programmed by the factory. If adding a new wall control, program into the operator before mounting the unit as detailed in the “Commissioning Remote Access Devices”.

! WARNING

Disconnect power to the operator whilst installing this accessory to prevent accidental activation.

Locate minimum 1.5 m above the floor to properly adjust the operator may result in serious personal injury from a closing door.

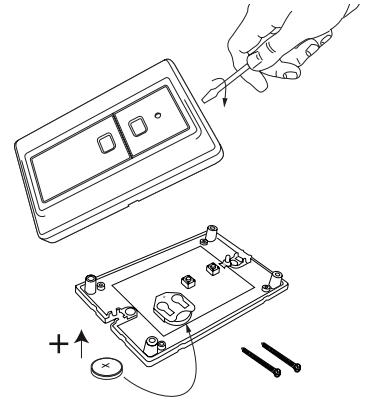

STEP 13

SETTING TIMER-TO-CLOSE

TIMER TO CLOSE feature: (TTC) 10 to 180 seconds.

NOTE: The Monitored Entrapment Protector System must be installed before TTC will operate. TTC is also disabled when operating on Battery

backup during power outages

The Timer to Close feature allows the door to automatically close after a specified time period. The courtesy light will flash 8 seconds before the door starts to move and continues to flash until the door is closed. If the door encounters an obstruction while closing, the operator will return to the OPEN position and the waiting period will begin again.

To activate the Timer to Close:

- Start with obstruction detection beams installed and the door fully CLOSED
- Press and Hold both “P” and DOWN buttons for 3 seconds. When the Courtesy light flashes “TWICE”, release both buttons
- Press the UP for each 10 second interval required for Timer to Close. A “BEEP” will register for each press. DOWN button will reduce the count if needed.
- Press and release the “P” button to accept this setting

To deactivate the Timer to Close:

- Start with the door fully CLOSED
- Press and Hold both “P” and DOWN buttons for 3 seconds. When the Courtesy light flashes “TWICE”, release both buttons.
- Press and release the “P” button to accept this setting

! WARNING

Door may operate unexpectedly, therefore do not allow anything to stay in the path of the door.

**ACTIVATE
TIMER TO
CLOSE**

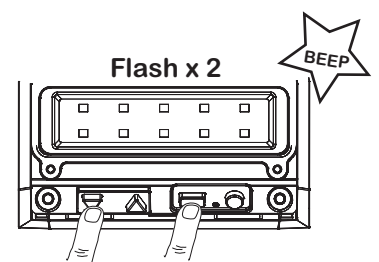

**SET
TIME**

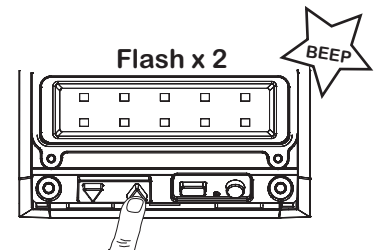

**ACCEPT
SETTING**

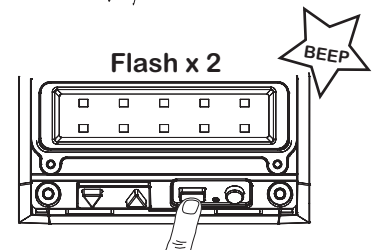

STEP 14

AUDIBLE BEEP (OPTIONAL)

The LR-DRIVE (GLD-RDO) has been factory set for an audible “BEEP”.

The Audible beep can be turned OFF by using the following method.

- Start with the door fully CLOSED.
- Press and Hold both “S” and DOWN buttons for 3 seconds
- The Courtesy light will flash “TWICE”. Release the buttons.

To turn the audible beep back ON, simply repeat the above process.

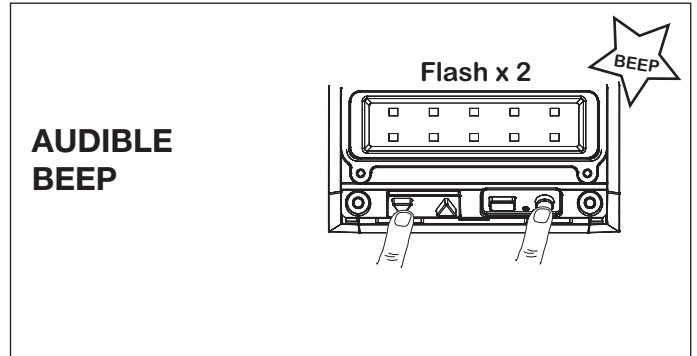

STEP 15

PROGRAM THE TRAVEL SPEED

There are two travel speeds available for this operator.

Factory preset is NORMAL speed.

A slower speed can be selected using the following process.

To activate the alternate speed:

PRESS and HOLD both the UP and DOWN arrows for 3 seconds. The courtesy lamp will flash once to confirm SLOW speed and twice to confirm REGULAR speed.

To deactivate the selected speed: Repeat the process above (toggle between the two settings).

STEP 16

VENTILATION MODE - PARTIALLY OPEN FEATURE

This is an adjustable, second stop position, that can be pre-set, partially opened for ventilation, for pedestrian or pet access. It is only operational with hand held remote controls, not Wireless Wall Controls (E138G).

MyQ Activation: It is not a normal feature of the MyQ phone App, however, from the pre-set position, an open door cannot be fully “CLOSED” but a closed door cannot be “OPENED” to the pre-set position.

To activate the ventilation mode:

1. Start with the door fully CLOSED (figure 1). Drive the operator UP and stop at the position required for you wish to set the door at.
2. Enter ventilation activation mode by pressing the P and UP buttons together for 3 seconds (figure 2). Release when the courtesy light flashes once.
3. Press the remote control button that you have allocated for this feature (figure 3). Do not use the button already allocated for normal operation. The courtesy light will flash when the code is accepted.

The remote will now operate to and from the “programmed” and the “fully closed position”. Outside this range the remote will operate as normal.

To Deactivate the Partial Opening Feature:

1. Start with the door fully CLOSED.
2. Enter ventilation mode by pressing the P and UP buttons together for 3 seconds (figure 2). The courtesy light will flash twice, indicating that deactivation has occurred.

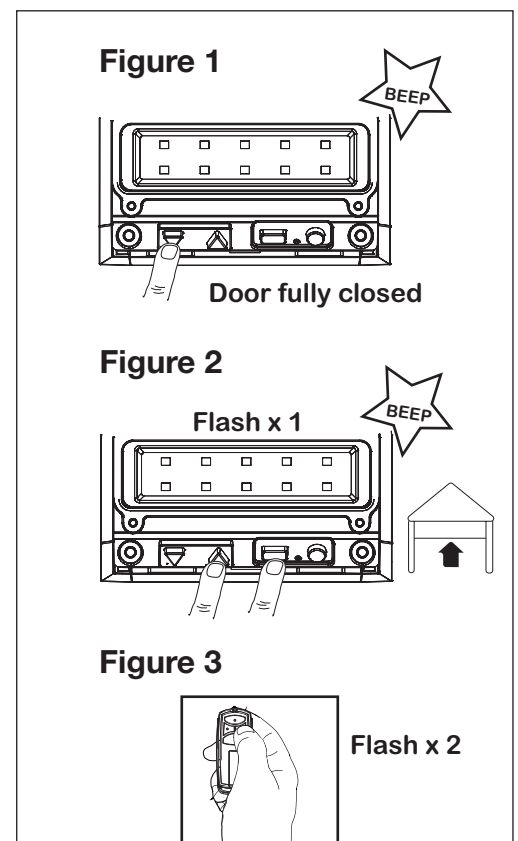

STEP 17

COMMISSIONING REMOTE ACCESS DEVICES

NOTE: The transmitters and wireless wall button supplied with your operator are preprogrammed by the factory.

If you purchase additional transmitters, the Operator must be programmed to accept the new remote code.

Program the receiver to match additional transmitter codes: Using the “S” SAVE Button

1. Press and hold the button on the remote that you wish to use (1)
2. Press the “S” button on the operator for 1 second (2)
3. Release the remote button when the courtesy light flashes twice. It has learnt the code. If you release the remote control push button before the operator light flashes, the operator has not learnt the code.

Now the operator will operate when the remote control button is pressed.

To Erase all Remote Control Codes:

1. Press and hold the “S” button on the operator until the courtesy light flashes twice, and continue holding for approximately 8 seconds, until the courtesy light flashes twice again.
2. Release the button, all remote codes are now erased.

To Erase all Remote Control and the MyQ activation code:

1. Press and hold the “S” button on the operator until the courtesy light flashes twice, and continue holding for approximately 8 seconds, until the courtesy light flashes twice again.
2. Release the button and immediately Press and Hold the “S” button again to repeat step 1.
3. Release the button, all remote and MyQ codes are now erased.

Wireless Keypad E840G

To set the keyless entry PIN:

1. Locate the yellow “S” button on the door operator.
2. Press and release the yellow “S” button. The LED indicator light will glow steadily.
3. Enter a 4-digit personal identification number (PIN) of your choice on the keypad.
4. Press and hold the ENTER button. Check to see if the operator light flashes. Release the ENTER button after the light flashes.

To change an existing keyless entry PIN:

1. Enter the existing programmed PIN that you want to change.
2. Press and hold the # button until the LED indicator light flashes twice.
3. Enter the new 4-digit PIN of your choice, then press the ENTER button. The light will flash once.
4. To test, enter the new PIN, then press the ENTER button. The operator will activate.

WARNING

Activate the operator only when door is in full view, free of obstruction and properly adjusted. No one should enter or leave garage while door is in motion. Do not allow children to operate push button(s) or remote(s). Do not allow children to play near the door.

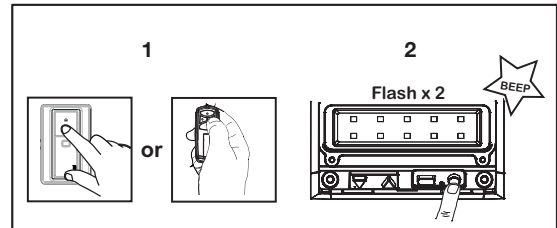

Wireless keypad

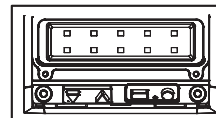

● Locate the “S” Button

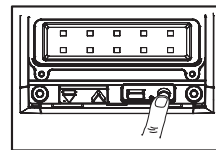

● Press & Release the “S” Button

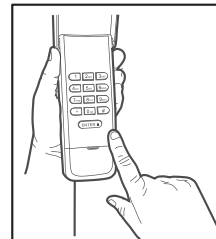

Enter a 4-digit code of your choice

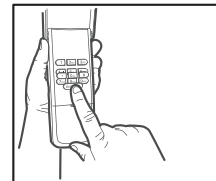

Press & hold the Enter Button until the operator light flashes

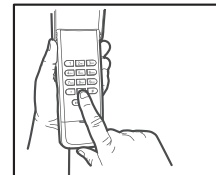

After the lights flash release the Enter Button

STEP 18

COMMISSIONING KEYSWITCH

Key switches are wired into the LR-Drive terminal board as shown right.

When closing the door via a keyswitch wired into the Hold-to-Close terminal (terminal 4) the operator will ignore the latch-to-close force reversal setting.

If Latch-to-Close is required, the keyswitch should be wired into terminal 3.

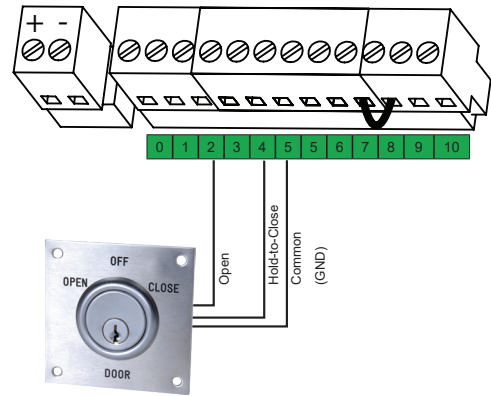

STEP 19

COMMISSIONING MyQ

MyQ INTERNET GATEWAY (not provided)

LR-Drive is compatible with Chamberlain Group's MyQ connectivity feature.

You will need a broadband internet connection to use the Internet Gateway.

Grifco Monitored Entrapment Protection is required to enable myQ control. Refer to page 5 for wiring details and refer to the safety device's manual for more information.



PROGRAMMING MyQ

Please refer to the MyQ manual supplied with the Internet Gateway.

STEP 20

COMMISSIONING FIRE OPEN INPUT

Activation of the Fire OPEN Input will hold an open door open, or open a closed or closing and hold the door at the fully open position.

While the Fire OPEN Input is active, all other inputs or commands will be ignored. When the Fire OPEN Input is released, the opener will respond to other commands, including Timer-To-Close, allowing the door to close.

Wiring Process:

Connect the N/O Fire Signal to Terminals 2 and 5.

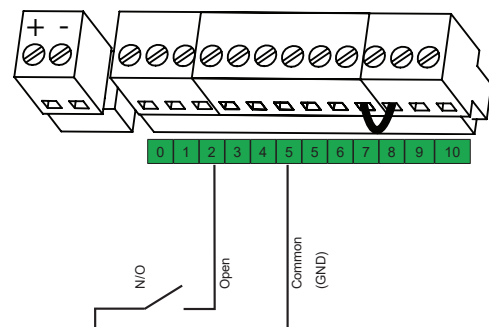

Test Operation

Activate the Fire OPEN Input and latch. After three seconds, the opener will drive the door to the OPEN position and hold open.

Test the operation using a transmitter or other close command. The door will remain open, and the Control Panel will now display a 5-1 diagnostic code.

Release the Fire OPEN Input. Test the operation using a transmitter or other close command. The opener will now drive the door to the CLOSED position.

ACCESSORIES

TYPES OF ACCESS DEVICES

All Grifco remote access devices feature Security +2.0 technology. This advanced platform cuts through interference, and ensures consistent, reliable, long range operation of your commercial door.

With inbuilt perpetual rolling code technology, Grifco Security +2.0 transmitters are safe and secure. All devices feature exceptional battery life, easy configuration and long range.

SECURITY +2.0 REMOTE ACCESS DEVICES

E960G

4-Channel Keyring Transmitter



STAR1000EVO

Transmitter Management Device



E138G

2-Channel Wall Transmitter



E840G

Wireless Security Keypad



WIRED KEY SWITCHES



KS103



KS103HP



KS104



KS107



KS111



KS106

USING YOUR OPERATOR

1. Your operator can be activated by any of the following devices:

- Operator control panel: Up and Down Buttons
- The Outside Keyswitch or Keyless Entry System (if you have installed either of these accessories).
- The Remote Control Transmitter. Hold the push button down until the door starts to move.
- MyQ access device (if connected).

2. Opening the Door Manually: DOOR SHOULD BE FULLY CLOSED IF POSSIBLE. Weak or broken springs could allow an open door to fall rapidly. Property damage or serious personal injury could result.

The door can be opened manually by pulling the release handle down. To reconnect the door, pull the manual release rope towards the operator until it springs back to its original horizontal position.

Do not use the manual release handle to pull the door open or closed.

3a. When TTC is not set.

When the Operator is Activated by Remote Control:

1. If open, the door will close. If closed, the door will open.
2. If closing, the door will stop.
3. If opening, the door will stop.
4. If the door has been stopped in a partially open or closed position, it will reverse direction.
5. If an obstruction is encountered while closing, the door will reverse to the OPEN limit position.
6. If an obstruction is encountered while opening, the door will stop and reverse for a short distance.
7. The Safety Beam uses an invisible beam which, when broken by an obstruction, causes a closing door to open and prevents an open door from closing.

3b. When TTC is set.

When the Operator is Activated by Remote Control:

1. If open, the door will not move, but the timer will reset
2. If closing, the door will stop and open.
3. If opening, the door will continue towards the open limit.
4. If the door has been stopped in a partially open or closed position, it will open.
5. If an obstruction is encountered while closing, the door will open.
6. If an obstruction is encountered while opening, the door will stop and reverse for a short distance.
7. The Safety Beam uses an invisible beam which, when broken by an obstruction, causes a closing door to open and prevents an open door from closing.

4. The operator lights will turn on under the following conditions: when the operator is initially plugged in; when power is restored after interruption or when the operator is activated. Lights will turn off automatically after 2-1/2 minutes.

CARE OF YOUR OPERATOR

Once a Month

- Disconnect power cord when performing service or maintenance.
- Manually operate door. If it is unbalanced or binding, call a qualified door technician.
- Check to be sure door opens & closes fully. Adjust limits and/or force if necessary.

Every Three Years

- Replace Battery Backup Unit (Part Number GLD-BBU24V)



WARNING

Before opening the door manually, ensure door is at its CLOSED limit position if possible.

REPLACE BATTERIES IN TRANSMITTERS

Battery of the transmitters:

The batteries in the transmitter have a long life.

If the transmission range decreases, the batteries should be replaced. Batteries are not covered by the warranty.



WARNING! This product contains a button/coin cell battery.

- The battery is hazardous.
- Keep new and used batteries away from children.
- Do not ingest battery. Chemical burn hazard.
- If the coin cell battery is swallowed or placed inside any part of the body, it can cause severe or fatal injuries in 2 hours or less.
- If the battery compartment does not close securely, stop using the product and keep away from children.
- If you think batteries might have been swallowed or placed inside any part of the body, call the 24-hour Poisons Information Centre on 13 11 26 in Australia, or the 24-hour National Poisons Centre on 0800 764 766 in New Zealand, or seek immediate medical attention.
- Dispose of used coin/button cell batteries immediately and safely. Flat batteries can still be dangerous.

Replacing battery (CR2032 or equivalent):

To replace the battery, turn the transmitter around and open the case with a screwdriver. Lift the cover and lift the control board. Slide the battery to one side and remove the old battery. Be sure to observe the polarity of the battery.

Assemble the transmitter again following the steps in reverse.

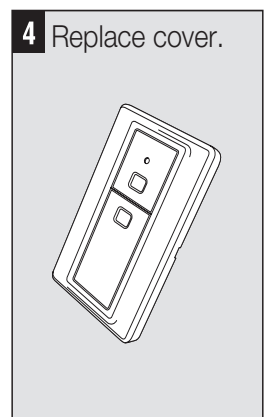
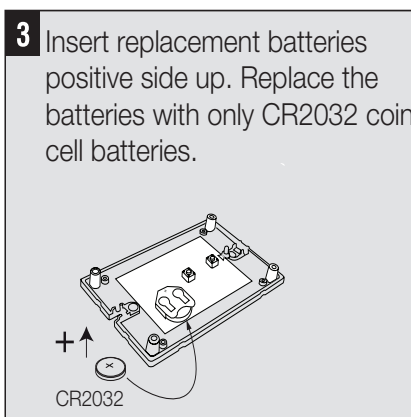
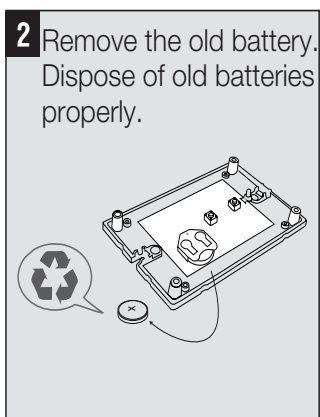
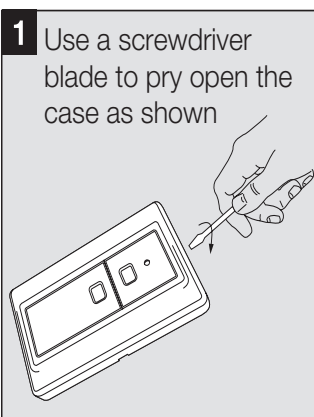
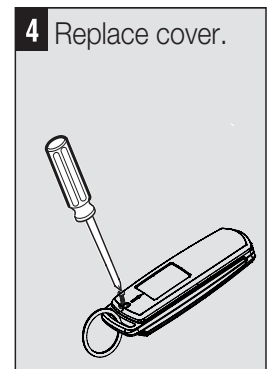
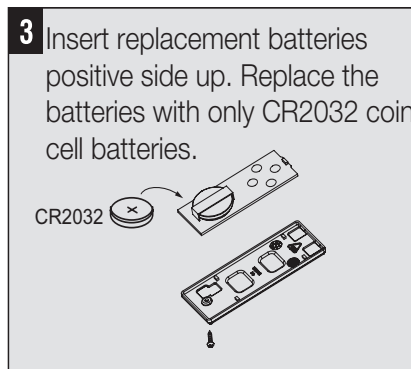
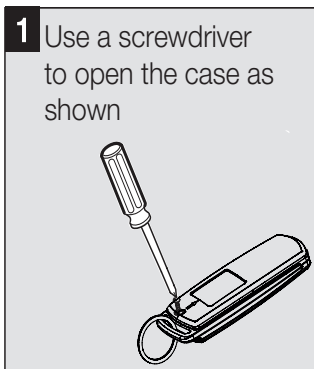

TROUBLESHOOTING

1. The operator will not operate from either the UP/DOWN activation button or the transmitters:
 - Does the operator have electric power? Plug a lamp into the outlet. If it does not work, check the fuse box.
 - Have you disabled all door locks? Review the installation instruction warnings on page 1.
 - Is there a build-up of ice or snow under the door? The door may be frozen to the ground. Remove any restriction.
 - The garage door spring may be broken. Have it replaced by contacting a garage door repairer.
 - The Fire OPEN Input has been activated, Check for 5-1 error code.
 2. The door operates from the UP/DOWN activation buttons but not from the wireless wall control or transmitter:
 - Program the operator to match the transmitter code.
 - Repeat with all transmitters.
 - Check and replace the batteries if necessary
 3. The transmitter has short range:
 - Change the location of the transmitter.
 - Check to be sure the antenna on the bottom of the operator extends fully downward.
 - Some installations may have shorter range due to a metal door, foil backed insulation, or metal garage siding.
 - The batteries may be flat. Replace the batteries.
 4. The door operates from the remote controls, but not from the MYQ Internet device. (Iphone app etc):
 - Check your internet service and router is active. (Are other household devices operational?)
 - Check the MyQ Gateway Device is On and Connected. (refer to page 17 to confirm the Green and Blue led status is correct)
 - Confirm your MyQ APP is functioning, use the website to confirm the system is operational.
 - If the door will only OPEN, check the safety beams are not obstructed.
 - For other issues relating to MyQ activation, there are FAQs available on the MyQ APP that may assist.
 5. The garage door opens and closes by itself:
 - Be sure that no transmitter buttons are being pressed.
 - Clear the memory and re-program all wireless wall controls and transmitters.
 6. The door reverses and stops before opening completely:
 - Is something obstructing the door? Is it out of balance, or are the springs broken? Remove the obstruction or repair the door.
 7. The LED Indicators on the control panel are flashing in sequence:
 - Check the diagnostic code on page 22.
 8. The door opens but will not close (or reverses while closing):
 - Is something obstructing the door? Pull the manual release handle. Operate the door manually. If it is unbalanced or binding, call a trained door systems technician.
 - Clear any ice or snow from the garage floor area where the door closes.
 - Repeat the limit and force setting. Repeat safety reverse test after adjustments.
 9. Door reverses for no apparent reason and operator lights flash 10 times:
 - Check the Monitored Entrapment Protector System (if installed). If the red light on the beam is flashing, the alignment is incorrect.
 - The red light on the beams may not be on if the operator is in Standby mode. Activate the door to temporarily exit standby mode and check lights are on constantly. If the LEDs are flashing, realign the beams.
- If the Monitored Entrapment Protector System is installed and needs to be removed, the Operator will need to be programmed as follows:
- Note: MyQ Internet Activation will no longer function.**
- Remove the Entrapment Protection Wiring from the operator
 - Turn the power OFF for 5 seconds
 - Turn the power ON for 5 seconds
 - Again turn the power OFF for 5 seconds
 - Turn the power back on and test the operator for normal operation.
10. The operator strains to operate the door:
 - The door may be out of balance or the springs may be broken. Close the door and use the manual release to disconnect the door. Open and close the door manually. A properly balanced door will stay in any point of travel while being supported entirely by its springs. If it does not, disconnect the operator and call a trained door systems technician.
 11. The operator operator hums briefly, then will not work:
 - Check that the door is not in manual release mode (refer to step 6).
 - The garage door springs may be broken.
 - If the problem occurs on the first operation of the operator, the door may be locked. Disable any doorlocks.
 12. The operator will not operate due to a power failure:
 - Use the manual release handle to disconnect the door. The door can be opened and closed manually. When power is restored, re-engage the operator to operate it via a transmitter.

DIAGNOSTICS

The operator is programmed with self-diagnostic capabilities. The UP and DOWN arrows on the control panel indicate the diagnostic code.

DIAGNOSTIC CODE		SYMPTOM	POSSIBLE RESOLUTION
DOWN Arrow Flashes	UP Arrow Flashes		
1	1	The operator will not close and the courtesy light flashes.	Safety sensors are open circuit or wires may be cut. Inspect sensor wires for a disconnected or cut wire. Turn power off and reboot the operator.
1	2	The operator will not close and the courtesy light flashes.	There is a short circuit wire for the safety sensors. Inspect safety sensor wire at all staple points and replace wire or correct as needed. Turn power off and reboot the operator.
1	3	The door control will not function.	The wires for the door control are shorted or the door control is faulty. Inspect safety sensor wire at all staple points and connection points and replace wire or correct as needed.
1	4	The operator will not close and the courtesy light flashes.	Safety sensors are misaligned or were momentarily obstructed. Realign both sensors to ensure both LEDs are steady and not flickering. Make sure nothing is hanging or mounted on the door that would interrupt the sensors path while closing.
1	5	There is no door movement or operator accelerates before stopping suddenly.	No RPM pulses have been detected. Check the door manually for balance, binding or obstructions. Internally the possible cause may be the operator, logicboard or RPM sensor. Try resetting door travel limits. Contact service centre.
2	1	Operator fails to operate.	Possible PCB memory failure. Reboot operator by turning the mains power OFF and then ON after 15 seconds. Reprogram the door travel limits and force settings. Contact service centre.
2	2	Operator fails to operate.	Possible PCB Voltage failure. Reboot operator by turning the mains power OFF and then ON after 15 seconds. Reprogram the door travel limits and force settings. Contact service centre.
2	4	Operator fails to operate using the remote controls.	Possible receiver failure. Reboot operator by turning the mains power OFF and then ON after 15 seconds. Recode the transmitters. Contact service centre.
4	1	Door is moving down, stops and reverses.	Manually open and close the door. Check for binding or obstructions, such as a broken spring or door lock. If the door is binding or sticking contact a trained door systems technician. If door is not binding or sticking, reset the limits (refer to "Program the Travel Limits and Force" section).
4	2	Door is moving up, stops and reverses.	Manually open and close the door. Check for binding or obstructions, such as a broken spring or door lock. If the door is binding or sticking contact a trained door systems technician. If door is not binding or sticking, reset the limits (refer to "Program the Travel Limits and Force" section).
5	1	Operator fails to operate	Fire OPEN Input has been activated. Check the Fire Input (terminals 2 & 5).
5	5	Operator fails to operate	Low internal voltage on the logic board. Possible power transformer or logic board failure. Service required. Call a trained service specialist.

SERVICE AND REPAIR PARTS



If the supply cord is damaged, it must be replaced by the manufacturer, its service agent or similarly qualified persons in order to avoid hazard.

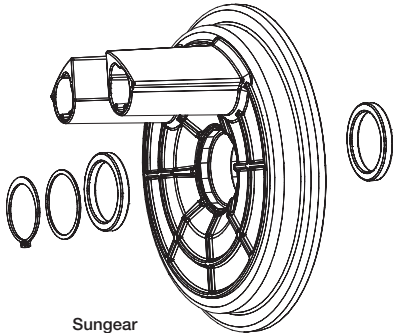

Sungear
002A2089

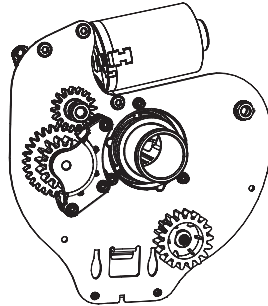

Sub Assembly
002A2086



Power Cord
002A2092

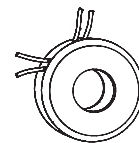

Transformer
002A2090

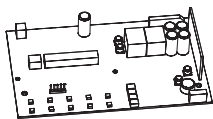

RDO PCB
002A2087

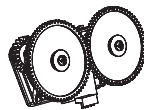

RDO Encoder Assembly
002A1959



Release Handle
002A2093

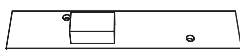

User Interface PCB
002A2088

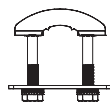

Clamp Assembly
002A2095



RDO Pole Clamp
002A1960

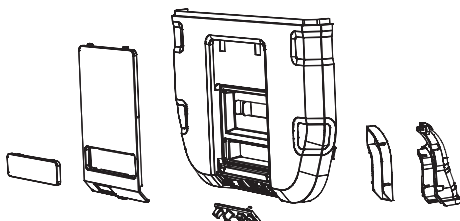

Front Lower Housing Assembly
002A2091

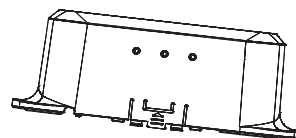

BBU Cover
002A2094

CHAMBERLAIN LIMITED WARRANTY - LR-DRIVE

Chamberlain Australia Pty Limited / Chamberlain New Zealand Limited (Chamberlain) is committed to manufacturing and supplying high quality goods. As part of this commitment, we seek to provide reliable service and support for our goods and are pleased to provide you, the original purchaser, with this Chamberlain Limited Warranty.

We also provide the following statement as required by the Australian Consumer Law: In Australia, in addition to your rights under this Chamberlain Limited Warranty, our goods come with guarantees that cannot be excluded under the Australian Consumer Law. You are entitled to a replacement or refund for a major failure and for compensation for any other reasonably foreseeable loss or damage. You are also entitled to have the goods repaired or replaced if the goods fail to be of acceptable quality and the failure does not amount to a major failure.

Chamberlain's warranty

Chamberlain warrants to the original purchaser of the Grifco product (Unit) that:

- 1 The LR-Drive Unit (including electric motor) is free from defects in materials and workmanship for a period of 24 months from the date of purchase or 10,000 cycles (whichever comes first).
- 2 During the applicable Chamberlain Warranty period, if you are concerned that the Unit or electric motor may be defective, call our service centre on the toll free number below before removing the Unit and a Chamberlain technician will diagnose the problem. Once the problem has been diagnosed, subject to your rights under the Australian Consumer Law with respect to major failures,

Chamberlain will provide you with:

- 1 parts for "do-it-yourself" repairs; or
- 2 shipping instructions for a factory repair or replacement.

If a factory repair or replacement is required, provided the defective part or Unit is returned to Chamberlain well-packaged and in accordance with Chamberlain's shipping instructions,

Chamberlain will, subject to your rights under the Australian Consumer Law with respect to major failures in relation to the Unit, repair or, at its option where permissible, replace any defective part or Unit and return it to you at no cost; and

Exclusions

If our service centre determines that a warranty claim has been made in respect of a failure or defect arising under or out of any exclusion detailed below such that the claim is not covered under this Chamberlain Limited Warranty, we may, subject to your other rights and remedies as a consumer, charge you a fee to repair, replace and/or return the Unit to you.

This Chamberlain Limited Warranty does not cover any failure of, or defect in, the Unit due to:

- 1 non-compliance with the instructions regarding installation, operation, maintenance and testing of the Unit or of any product with which the Unit is used;
- 2 any attempt by a person other than an authorised installer to change settings, repair, dismantle, reinstall or move the Unit to another location once it has been installed;
- 3 tampering, neglect, abuse, wear and tear, accident, electrical storm, excessive use or conditions other than normal commercial use;
- 4 use of the Unit in conjunction with controls which have not been supplied, or pre-approved, by Chamberlain;
- 5 problems with, or relating to, the commercial door or commercial door hardware, including but not limited to the door springs, door rollers, door alignment, hinges, guides, slats and drums; or
- 6 problems caused by electrical faults.

If this Chamberlain Limited Warranty does not apply, you may have rights available to you under the Australian Consumer Law.

Liability – Australia only

Except as set out in the Australian Consumer Law (being Schedule 2 of the Competition and Consumer Act 2010) (as amended, consolidated or replaced):

- 1 all other guarantees, warranties and representations in relation to the Unit or its supply are excluded to the extent that Chamberlain can lawfully exclude them; and
- 2 under no circumstances will Chamberlain be liable for consequential, incidental or special damages arising in connection with the use, or inability to use, the Unit, other than those which were reasonably foreseeable as liable to result from the failure.

Liability – New Zealand only

Except as set out in the Fair Trading Act 1986 and the Consumer Guarantees Act 1993 (as amended, consolidated or replaced):

- 1 all other guarantees, warranties and representations in relation to the Unit or its supply are excluded to the extent that Chamberlain can lawfully exclude them; and
- 2 under no circumstances will Chamberlain be liable for consequential, incidental or special damages arising in connection with the use, or inability to use, the Unit, other than those which were reasonably foreseeable as liable to result from the failure.

Note

We request that you retain your sales docket or invoice as proof-of-purchase and attach it to this manual to enable you to establish the date of purchase in the unlikely event of a warranty service being required. Chamberlain reserves the right to change the design and specifications of the Unit without prior notification. Some features or accessories of the Unit may not be available in certain markets or areas. Please check with your distributor.

Chamberlain service centre contact details Australia

Phone toll free 1800 474 326

Fax toll free 1800 888 121

Unit 1, 75 Epping Road North Ryde, NSW 2113

Email customerservice@chamberlainnz.com

New Zealand

Auckland phone 09 477 2823

Phone toll free 0800 653 667

Fax toll free 0800 653 663

Website www.grifco.com.au or www.grifco.co.nz